

Descriptions

Benchtop and portable meters



Content

- 7 *IDS - Intelligent digital sensors*
- 7 *IDS goes wireless*
- 8 *Benchtop meters inoLab® Multi IDS - digital*
- 11 *Portable meters MultiLine® IDS - digital*
- 14 *Benchtop meters inoLab® - analogue*
- 18 *Portable meters ProfiLine - analogue*

IDS - Intelligent digital sensors

IDS focuses on the sensors. The unique WTW IDS sensors offer three main advantages:

- Reliable measurement results through clear assignment of the measured value to the sensor. Each IDS sensor transmits its description, serial number, and current calibration status
- Correct measurement results due to direct signal processing in the sensor and digital transmission of the values. Cable lengths up to 100 m for all parameters are easily possible
- High-quality, long-term proven sensors as a basis for IDS technology

Unique quality functions such as the intelligent sensor evaluation (QSC) at pH support operational safety by information about the actual state of the electrode.

IDS sensors are available for pH, ORP, dissolved oxygen, conductivity and turbidity.



IDS goes wireless



We have set another milestone in the measurement of pH/ORP, dissolved oxygen, conductivity and turbidity with the wireless transmission of measured parameters!

With the plug head IDS sensors and universal rechargeable wireless modules, all measurement problems in hard-to-reach locations such as fume hoods, safety workbenches, or any other place cables are convenient, can be mastered in no time at all. With a range of up to 10 meters, you can keep the instrument in a safe place and have a hand free.

Universal wireless modules for meters and sensors make working very easy.

- Each meter requires only one IDS WLM-M module
- One meter measures up to three sensor modules simultaneously, depending on the model
- A sensor module IDS WLM-S can be used with any IDS plug head sensor

Suitable for all new MultiLine® Multi 3630 IDS, Multi 3620 IDS, Multi 3510 IDS and inoLab® Multi 9630 IDS inoLab® Multi 9620 IDS and inoLab® Multi 9310 IDS.

Digital benchtop meters inoLab® IDS

Trusted measurements with the most modern multi-channel meters **inoLab® Multi 9630 IDS, inoLab® Multi 9620 IDS, inoLab® Multi 9310 IDS** All meters have the following:

- ✓ yes
- yes
- ✓ recommended
- ✓ recommended for some applications
- not recommended/not available

		Digital			
		inoLab® IDS			
		Multi 9630	Multi 9620	Multi 9310	
2 parameters simultaneously		✓	✓		
3 parameters simultaneously		✓			
pH	IDS-pH electrodes: SenTix® 9xx, SensoLyt® 900	28	●	●	●
	All SenTix® electrodes with DIN or BNC plug	65	●*	●*	
ORP	IDS ORP electrodes: SenTix® ORP 900-T, SensoLyt® ORP 900	32	●	●	●
	All SenTix® electrodes with DIN or BNC plug	73	●*	●*	●**
ISE (pH/ION function)	ISE electrodes	81	●*	●*	
	Ion-specific measurement programs	40	●	●	
Dissolved oxygen	IDS Optical dissolved oxygen sensor: FDO® 925	33	●	●	●
Conductivity	IDS Conductivity cells: TetraCon® 925, LR 925/01	34	●	●	●
Turbidity	IDS turbidity sensor VisoTurb® 900	36	●	●	●
Routine measurements		✓	✓	✓	
Routine measurement with documentation		✓	✓	✓	
AQA with documentation		✓	✓	✓	
R&D High resolution and precision		✓	✓	✓	
Control measurements		✓	✓	✓	
LIMS connection		✓	✓	✓	
Quality assurance		✓	✓	✓	
Education		✓	✓	✓	
Service		–	–	–	
Laboratory measurements		✓	✓	✓	
Field measurements		–	–	–	
Depth measurements		–	–	–	
Measurement according to pharmacopoeia:	Conductivity	✓***	✓***	✓***	
	diss. Oxygen	✓	✓	✓	
PC connection		✓	✓	✓	
Memory		✓	✓	✓	
USB interface		✓	✓	✓	
Printer option				✓	
Graphic display				✓	
Color graphic display		✓	✓		

* analogue electrodes can also be connected via an insertable DIN-/BNC adapter
 ** analogue electrodes with S7 plug head connectable via ADA S7/IDS
 *** via comparison measurement

Multi 9630	Multi 9620	Multi 9310
------------	------------	------------

see page 40 40 41

inoLab® Multi 9630 IDS/Multi 9620 IDS

The inoLab® Multi 9630 IDS and 9620 IDS are the top in their class. They are wireless ready and measure three (9630) or two (9620) of the following parameters simultaneously: pH, ORP, ISE, dissolved oxygen, conductivity or turbidity.

Complete GMP/GLP compliant documentation is possible.

Housing

High-quality housing with die-cast zinc lower case, large color display and antibacterial keyboard.

Display

Large color graphic display in 16: 9 format, with CMC, QSC and measurement channel display, as well as soft keys for additional functions. Depending on the number of channels present, two or three main parameters are shown simultaneously. Individual presentation is also possible. Hygienic, easy-to-clean glass pane.

Connectors

High-quality, tightly sealed socket field with moulded connectors for IDS sensors. There are three connections on the inoLab® Multi 9630, and two connections on the inoLab® Multi 9620

Keyboard

Easy-to-clean, antibacterial membrane keypad with clear pressure points for convenient operation and hygienic work.

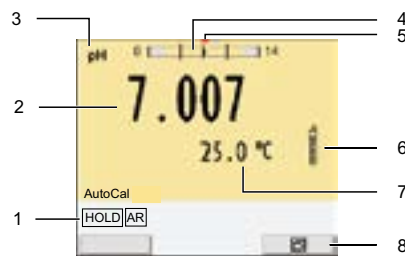

- 1 Status information
- 2 Measurement value (with unit)
- 3 Measured parameter
- 4 Continuous measurement value control (CMC function; with pH measurement)
- 5 Display of the active sensor connection (measurement channel display)
- 6 Sensor symbol (calibration evaluation)
- 7 Temperature measurement value (with unit)
- 8 Soft keys and date/time

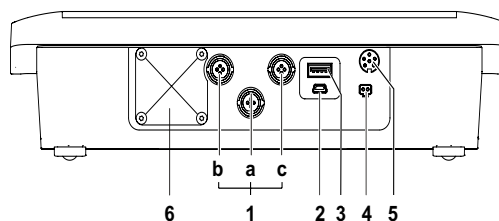

- 1 Three or two universal IDS sensor connectors (measurement channels) also for IDS wireless module
- 2 Mini USB-B for the connection to a PC (data transfer, firmware update, set up of a user management, power supply via USB)
- 3 USB-A socket for the connection of USB memory stick or selected printers
- 4 Connection for power supply through AC adapter
- 5 Service interface
- 6 Plug location for analogue pH/mV/ISE module

Order information see page 42

inoLab® Multi 9310 IDS

The compact all-rounder of the IDS family: With one measuring channel and wireless ready pH, ORP, dissolved oxygen, conductivity and turbidity can be measured.

Comes with all the advantages of IDS technology, such as complete GLP documentation of all meter and sensor data.

Housing

Smooth plastic housing with rounded edges and stand base for bolting on. A version with a built-in thermal printer (58 mm) is available.

Display

Bright and high-contrast black and white graphic display with soft keys and clear presentation.

Connectors

High-quality socket field with tightly sealed connection for IDS sensors (one connection).

Keyboard

Smooth and easy-to-clean membrane keypad in a user-friendly layout with clear pressure points.

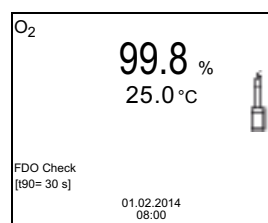
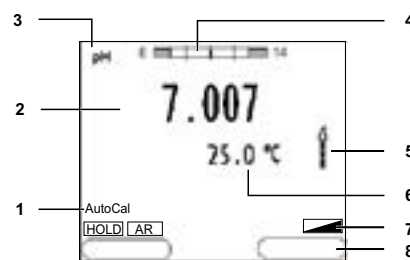

- 1 Status information
- 2 Measurement value (with unit)
- 3 Measured parameter
- 4 Continuous measurement value control (CMC function; with pH measurement)
- 5 Sensor symbol (calibration evaluation)
- 6 Temperature measurement value (with unit)
- 7 Status information (meter)
- 8 Soft keys and date/time

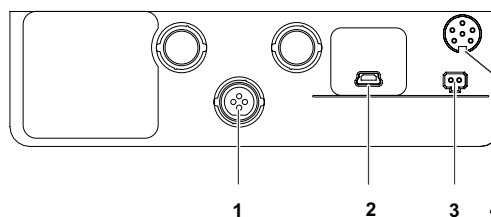

- 1 Universal IDS sensor connections (measurement channels), also for IDS wireless module
- 2 Mini USB-B for the connection to a PC (data transfer, firmware update, set up of a user management, power supply via USB)
- 3 Connection for power supply through AC adapter
- 4 Service interface

Order information see page 42

Digital portable meters MultiLine® IDS

The digital portable meters for IDS sensors: **Multi 3630 IDS, Multi 3620 IDS, Multi 3510 IDS**: State-of-the-art portable measurement pH/mV, dissolved oxygen, conductivity and turbidity as well as depth profile measurement (Multi 3630 IDS). Robust, field-suitable and prepared for wireless measurement. Also available in a sets with various sensors.

- ✓ yes
- yes
- ✓ recommended
- ✓ recommended for some applications

		Digital			
		MultiLine® IDS			
		Multi 3630	Multi 3620	Multi 3510	
2 parameters simultaneously		✓	✓		
3 parameters simultaneously		✓			
pH	IDS-pH electrodes: SenTix® 9xx, SensoLyt® 900	28	●	●	●
	All SenTix® electrodes with S7 plug head	65	●**	●**	●**
ORP	IDS ORP electrodes: SenTix® ORP 900-T, SensoLyt® ORP 900	32	●	●	●
	All SenTix® electrodes with S7 plug head	73	●**	●**	●**
Dissolved oxygen	IDS dissolved oxygen sensor: FDO® 925	33	●	●	●
Conductivity	IDS measuring cells: TetraCon® 925, LR 925/01	34	●	●	●
Turbidity	IDS turbidity sensor: VisoTurb® 900-P	36	●	●	●
Multi-parameter	IDS Depth sonde MPP 930	38	●		
Routine measurements		✓	✓	✓	
Routine measurements with documentation		✓	✓	✓	
AQA with documentation		✓	✓	✓	
R&D: High resolution and precision		✓	✓	✓	
Control measurements		✓	✓	✓	
LIMS connection		✓	✓	✓	
Quality assurance		✓	✓	✓	
Education		✓	✓	✓	
Service		✓	✓	✓	
Laboratory measurements		✓	✓	✓	
Field measurements		✓	✓	✓	
Depth measurements		✓	✓	✓	
PC connection		✓	✓	✓	
Memory		✓	✓	✓	
USB interface		✓	✓	✓	
Graphic display				✓	
Color graphic display		✓	✓		
* analogue electrodes can also be connected via an insertable DIN-/BNC adapter					
** analogue electrodes with S7 plug head connectable via ADA S7/IDS					
		Multi 3630	Multi 3620	Multi 3510	

see page 44 45 46

Multi 3630 IDS/Multi 3620 IDS

Highest measurement safety and comfort in the field: The Multi 3630 IDS and 3620 IDS wireless ready portable meters are waterproof, robust and leave nothing to be desired in terms of parameter selection, operating comfort and data transmission options.

Housing

Water- and dust-tight housing according to IP 67 for use outdoors and in a facility The armor SM Pro (component of the sets, as well as in the individual scope of delivery) offers additional protection.

Display

Brilliant color graphic display with clear plastic pane, with CMC, QSC and channel display, as well as soft keys for additional functions. Depending on the number of channels present, two or three main parameters can be shown simultaneously, or a single channel may be displayed alone if prefer.

Connectors

Inwardly waterproof sealed socket field with three or two universal sensor connectors, when plugged in IP 67 (also for IDS wireless module).

Keyboard

Silicon keyboard that can also be operated with gloves made of one piece with embossed keys and tactile and acoustic feedback. waterproof and easy to clean.

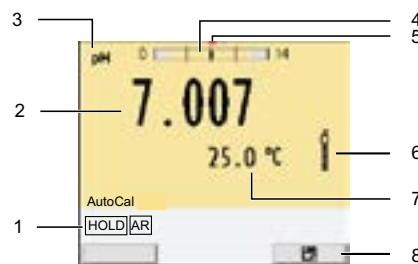

- 1 Status information
- 2 Measurement value (with unit)
- 3 Measured parameter
- 4 Continuous measurement value control (CMC function; with pH measurement)
- 5 Display of the active sensor connection (measurement channel display)
- 6 Sensor symbol (calibration evaluation)
- 7 Temperature measurement value (with unit)
- 8 Soft keys and date/time

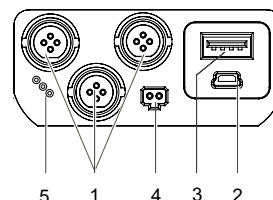

- 1 Three or two universal IDS sensor connections (measurement channels) also for IDS wireless module
- 2 Mini USB-B for the connection to a PC (data transfer, firmware update, set up of a user management, power supply via USB)
- 3 USB-A socket for the connection of USB memory stick or selected printers
- 4 Connection for power supply through AC adapter
- 5 Service interface



Order information see page 46

Multi 3510 IDS

Simply Multi: With one measuring channel and wireless ready, pH, ORP, dissolved oxygen, conductivity and turbidity can be measured sequentially. Robust and reliable in the field with IDS technology for complete documentation of all meter and sensor data.

Housing

Water- and dust-proof housing according to IP 67 for use outdoors and in a facility.

Display

Backlit black/white graphic display, also for use in challenging lighting conditions. Supports QSC and CMC display, contains soft keys for additional functions.

Connectors

Waterproof sealed socket field with a sensor connection, when plugged in IP 67 (also for IDS wireless module).

Keyboard

Silicon keyboard that can be operated with gloves and has tactile and acoustic feedback. One piece molded design is waterproof and easy to clean.

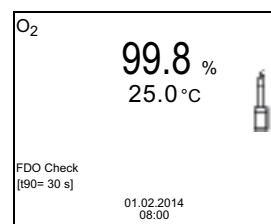
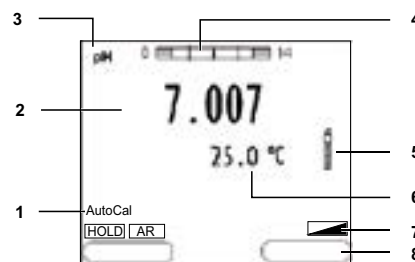

- 1 Status information
- 2 Measurement value (with unit)
- 3 Measured parameter
- 4 Continuous measurement value control (CMC function; with pH measurement)
- 5 Sensor symbol (calibration evaluation)
- 6 Temperature measurement value (with unit)
- 7 Battery display
- 8 Soft keys and date/time

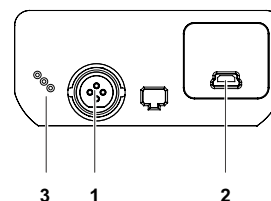

- 1 Universal IDS sensor connections (measurement channels), also for IDS wireless module
- 2 Mini USB-B for the connection to a PC (data transfer, firmware update, set up of a user management, power supply via USB)
- 3 Service interface

Order information see page 46

Analogue benchtop meters inoLab®



The inoLab® family has long been a well-known term for first-class benchtop meters for the measurement of standard parameters such as pH/mV, ion concentrations, dissolved oxygen and conductivity. **The inoLab® 7320, inoLab® 7310 and inoLab® 7110 lines leave nothing to be desired during measurement.** All meters of the 7310 and 7110 lines are also available in sets with sensors.

- ✓ yes
- yes
- ✓ recommended
- ✓ recommended for some applications
- not recommended/not present

	analogue					
	inoLab®					
	pH 7110	Cond 7110	pH 7310	Oxi 7310	Cond 7310	pH/ION 7320
2 parameters simultaneously						✓
pH	●		●			●
ORP	●		●			●
ISE						●
Dissolved oxygen				●		
Conductivity		●			●	
Routine measurements	✓	✓	✓	✓	✓	✓
Routine measurements with documentation			✓	✓	✓	✓
AQA with documentation			✓	✓	✓	✓
R&D - high resolution and precision			✓	✓	✓	✓
Control measurements	✓	✓	✓	✓	✓	✓
LIMS connection			✓	✓	✓	✓
Quality assurance			✓	✓	✓	✓
Education	✓	✓	✓	✓	✓	✓
Service	–	–	–	–	–	–
Laboratory measurements	✓	✓	✓	✓	✓	✓
Field measurements						
PC connection			✓	✓	✓	✓
Memory			✓	✓	✓	✓
USB interface			✓	✓	✓	✓
Graphic display			✓	✓	✓	✓
			Compatible sensor systems			
			Analogue electrodes			
pH electrodes	65		✓			✓
ORP electrodes	73		✓			✓
ISE electrodes	81					✓
Dissolved oxygen sensors	92			✓		
Conductivity cells	105	✓			✓	

see page 57 99 57 88 98 42

inoLab® 7310

Reliable, conveniently operated benchtops with documentation functions for GLP measurement in the laboratory with analogue sensors for pH/ORP, dissolved oxygen and conductivity. Also available with a built in printer.

Housing

Smooth plastic housing with rounded edges and attachable stand. Available with built-in thermal printer (58 mm).

Display

Backlit graphic display with clearly structured menus for comfortable and safe operation.

Connectors

High-quality socket field with a connector for analogue pH/ORP or oxygen or conductivity sensors.

Keyboard

Smooth and easy to clean membrane keypad with convenient pressure points and acoustic feedback. Clear layout to support optimal operation.

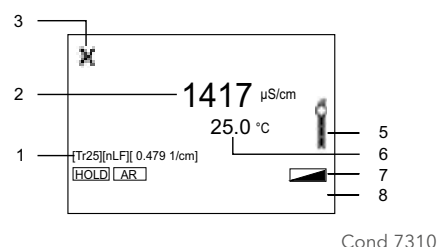
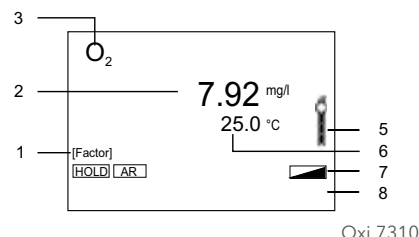
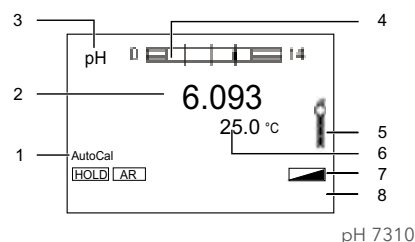

- 1 Status information
- 2 Measurement value (with unit)
- 3 Measured parameter
- 4 Continuous measurement value control (CMC function; with pH 7310)
- 5 Sensor symbol (calibration evaluation)
- 6 Temperature measurement value (with unit)
- 7 Status information (meter)
- 8 Soft keys and date/time

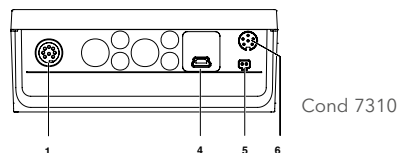
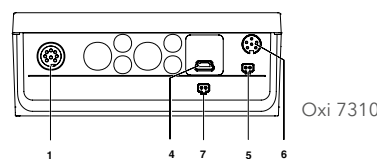
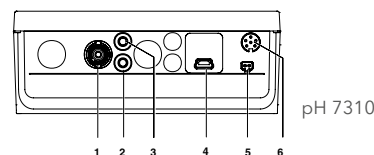

- 1 Connection for pH electrode or conductivity or dissolved oxygen sensor
- 2 Reference electrode (with pH 7310)
- 3 Temperature sensor (with pH 7310)
- 4 Mini USB-B interface for data transfer and firmware update
- 5 Connection for power supply
- 6 Service interface
- 7 Power supply for StirrOx dissolved oxygen sensor (with Oxi 7310)

Order information see page
57 (pH) 88 (Oxi) 99 (Cond)

inoLab® pH/ION 7320

Precise 2-channel benchtop meter for pH/ISE/ORP measurement with analogue sensors and GLP-supporting documentation functions. With preprogrammed ISE incremental functions and on request with built-in printer.

Housing

Smooth plastic housing with rounded edges and stand to be fixed at the meter. If required with installed thermal printer (58 mm).

Display

Backlit graphic display for simultaneous display of the two measuring inputs. Clearly structured menus for convenient and safe operation.

Connectors

DIN or BNC sockets for pH/mV sensors, with additional inputs for reference electrodes and temperature sensor; 8 pin inputs for conductivity and oxygen electrodes.

Mini USB-B interface for data transfer and firmware update, socket for power supply.

Keyboard

Smooth and easy to clean membrane keypad with pleasant pressure points and acoustic feedback.

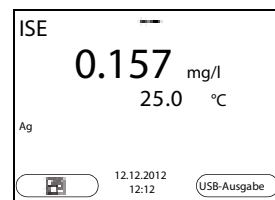
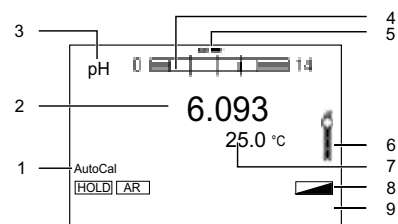

- 1 Status information
- 2 Measurement value (with unit)
- 3 Measured parameter
- 4 Continuous measurement value control (CMC function; with pH measurement)
- 5 Channel display Plug position of the sensor
- 6 Sensor symbol (calibration evaluation)
- 7 Temperature measurement value (with unit)
- 8 Status information (meter)
- 9 Soft keys and date/time

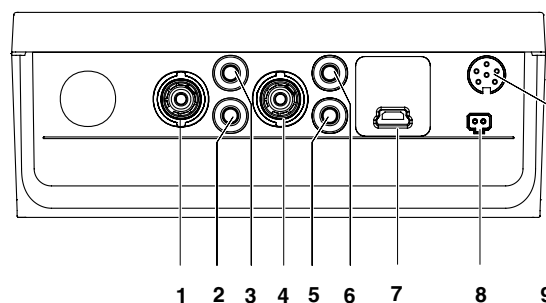

- 1 Connection for pH electrode or ISE electrode (channel 1)
- 2 Reference electrode (with pH /ISE measurement)
- 3 Temperature probe (with pH /ISE measurement)
- 4 Connection for pH electrode or ISE electrode (channel 2)
- 5 Reference electrode (with pH /ISE measurement)
- 6 Temperature probe (with pH /ISE measurement)
- 7 Mini USB-B interface for data transfer and firmware update
- 8 Connection for power supply through AC adapter
- 9 Service interface

Order information see page 78

inoLab® 7110

Easy-to-use benchtop meters for the routine measurement of pH/ORP or conductivity. With a smooth, easy-to-clean surface and large, clear display.

Housing

Compact plastic housing with rounded edges and smooth surface. With separate attachable electrode stand.

Display

Large, clear and easy-to-read LCD segment display.

Connectors

Quality is also the top priority for these meters. High-quality socket field made of one cast, DIN or BNC sockets for pH/mV sensors, with additional inputs for reference electrodes and temperature sensors; 8 pin inputs for conductivity electrodes, socket for plug power supply.

Keyboard

Smooth, easy to clean membrane keypad with convenient pressure points and acoustic feedback. Reduced numbers of keys for easy and safe operation.

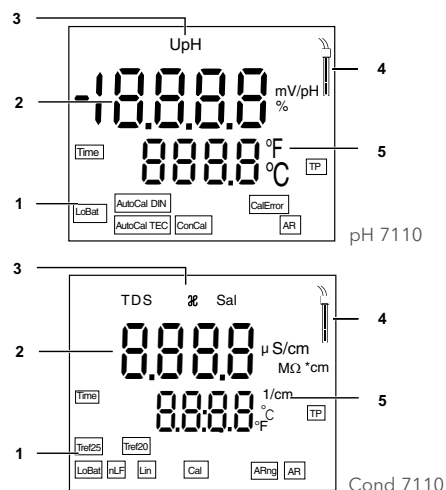

- 1 Status information
- 2 Measurement value (with unit)
- 3 Measured parameter
- 4 Sensor symbol (calibration evaluation))
- 5 Temperature measurement value (with unit)

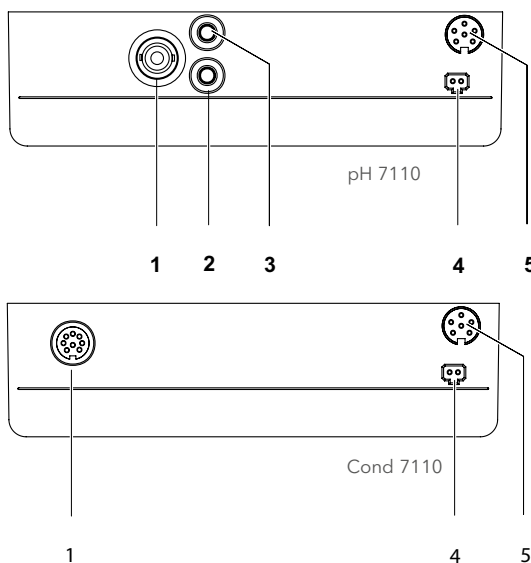

- 1 Connection for pH electrode or conductivity cell
- 2 Reference electrode (with pH measurement)
- 3 Temperature probe (with pH measurement)
- 4 Connector for power supply through AC adapter
- 5 Service interface

Order information see page
57 (pH) 99 (Cond)

Analogue portable meters ProfiLine

The proven ProfiLine family of analogue portable meters for the mobile measurement of pH/mV, dissolved oxygen and conductivity. Robust, field-suitable multi and ISE single parameter meters. On request available in sets with proven sensors.

- ✓ yes
- yes
- ✓ recommended
- ✓ recommended for some applications

		analogue								
		ProfiLine								
		pH 3110	Oxi 3205	Cond 3110	pH 3310	Oxi 3310	Cond 3310	pH/ION 3310	Multi 3320	pH/Cond 3320
2 parameters simultaneously									✓	✓
pH/ORP		●			●			●	●	●
ISE								●	●	●
Dissolved oxygen			●			●			●	
Conductivity				●			●		●	●
Routine measurements		✓	✓	✓	✓	✓	✓	✓	✓	✓
Routine measurements with documentation					✓	✓	✓	✓	✓	✓
AQA with documentation					✓	✓	✓	✓	✓	✓
R&D: high resolution and precision					✓	✓	✓	✓	✓	✓
Control measurements		✓	✓	✓	✓	✓	✓	✓	✓	✓
LIMS connection					✓	✓	✓	✓	✓	✓
Quality assurance					✓	✓	✓	✓	✓	✓
Education		✓	✓	✓	✓	✓	✓	✓	✓	✓
Service		✓	✓	✓	✓	✓	✓	✓	✓	✓
Laboratory measurements		✓	✓	✓	✓	✓	✓	✓	✓	✓
Field measurements		✓	✓	✓	✓	✓	✓	✓	✓	✓
PC connection					✓	✓	✓	✓	✓	✓
Memory					✓	✓	✓	✓	✓	✓
USB interface					✓	✓	✓	✓	✓	✓
Graphic display			✓		✓	✓	✓	✓	✓	✓
		Compatible sensor system								
		Analogue electrodes								
pH electrodes	65	✓			✓			✓	✓	✓
ORP electrodes	73	✓			✓			✓	✓	✓
ISE electrodes	81							✓	✓	✓
Dissolved oxygen sensors	92		✓			✓			✓	✓
Conductivity cells	106			✓			✓		✓	✓
		pH 3110	Oxi 3205	Cond 3110	pH 3310	Oxi 3310	Cond 3310	pH/ION 3310	Multi 3320	pH/Cond 3320

see page 62 91 104 61 91 103 80 49 50

ProfiLine 3320

Robust, waterproof multi-parameter instruments with extensive measuring functions for mobile use, available in the combinations pH, ORP, ISE, conductivity and pH, ORP, ISE, conductivity dissolved oxygen.

Housing

IP 67 rated, water- and dust-tight housing for use outdoors and in facilities. Compatible with the SM Pro protective case.

Display

Backlit BW graphic display, also for use in low light conditions for the simultaneous display of two measured parameters.

Connectors

Waterproof socket field suitable for field use with two sensor connections.

DIN or BNC sockets for pH/mV sensors, with additional input for temperature sensor; 8-pin inputs for conductivity and oxygen electrodes.

Mini USB-B interface for data transfer and firmware update, socket for power supply.

Keyboard

Silicon keyboard that can also be operated with gloves with raised keys, with tactile and acoustic feedback. Waterproof and easy to clean.

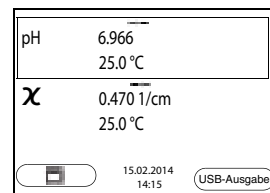
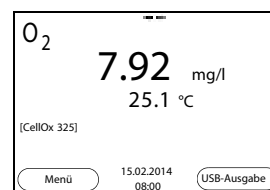
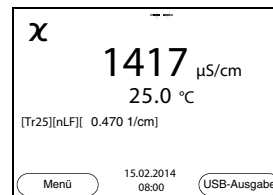
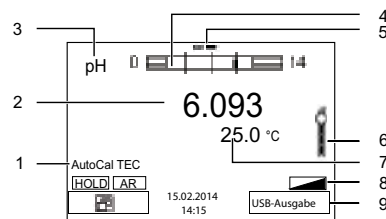

- 1 Status information (sensor)
- 2 Measurement value (with unit)
- 3 Measured parameter
- 4 Continuous measurement value control (CMC function; with pH measurement)
- 5 Channel display Plug position of the sensor
- 6 Sensor symbol (calibration evaluation)
- 7 Temperature measurement value (with unit)
- 8 Status information (meters)
- 9 Soft keys and date/time

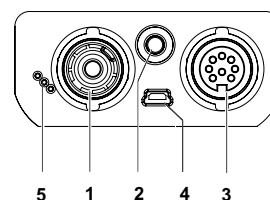

- 1 Connection for pH or ISE electrode
- 2 Reference electrode (with pH measurement)
- 3 Connection for conductivity or oxygen electrode
- 4 Mini USB-B interface for data transfer and firmware update
- 5 Service interface

Order information see page 50 (multi and pH/Cond)

ProfiLine 3310

Robust, waterproof single-parameter meters with extensive measuring functions for mobile use, available in the variants pH, ORP, ISE, conductivity and dissolved oxygen.

Housing

IP 67 rated Water- and dust-tight housing for use outdoors and in facilities. Compatible with the SM Pro protective case.

Display

Backlit black/white graphic display, for use in challenging lighting conditions.

Connectors

The 3310 has a waterproof DIN socket for pH/mV/ISE electrodes including reference and temperature sensor input, or a waterproof 8-pin socket for connecting WTW conductivity cells or dissolved oxygen sensors.

Keyboard

Silicon keyboard that can be operated with gloves and has tactile and acoustic feedback. One piece molded design is waterproof and easy to clean.

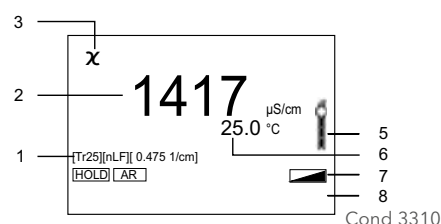
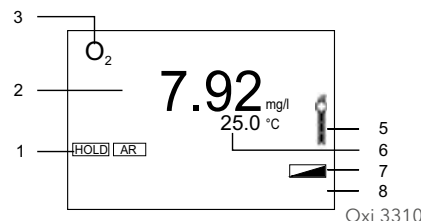
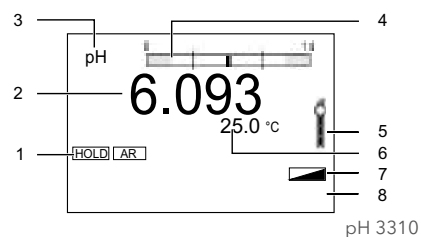

- 1 Status information
- 2 Measurement value (with unit)
- 3 Measured parameter
- 4 Continuous measurement value control (CMC function; with pH 3310)
- 5 Sensor symbol (calibration evaluation)
- 6 Temperature measurement value (with unit)
- 7 Battery display
- 8 Soft keys and date/time

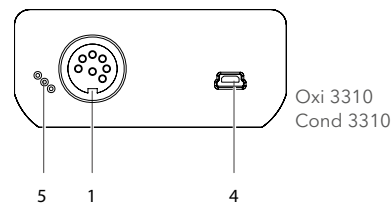
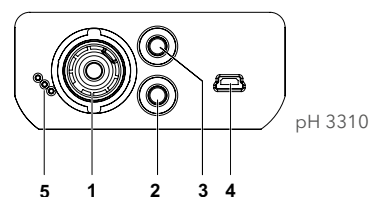

- 1 Connection for pH or ISE electrode or conductivity or dissolved oxygen sensor
- 2 Reference electrode (with pH measurement)
- 3 Temperature probe (with pH measurement)
- 4 Mini USB-B interface for data transfer and firmware update
- 5 Connection for power supply through AC adapter
- 6 Service interface

Order information see page
62 (pH) 90 (Oxi) 104 (Cond)

ProfiLine 3110/3205

Easy to use, robust and waterproof meters for portable use, for pH/ORP or conductivity measurement. Ideal for occasional measurements without documentation.

Housing

IP 67 rated Water- and dust-tight housing for use outdoors and in facilities. Compatible with the SM Pro protective case.

Display

The 3110 meter have a clearly structured and easy-to-read segment display. The 3205 has a backlit BW graphic display, for use in challenging lighting conditions.

Connectors

All sensor connections are IP 67 rated dust and waterproof. This ensures optimal signal transmission.

Keyboard

Silicon keyboard that can be operated with gloves and has tactile and acoustic feedback. One piece molded design is waterproof and easy to clean.

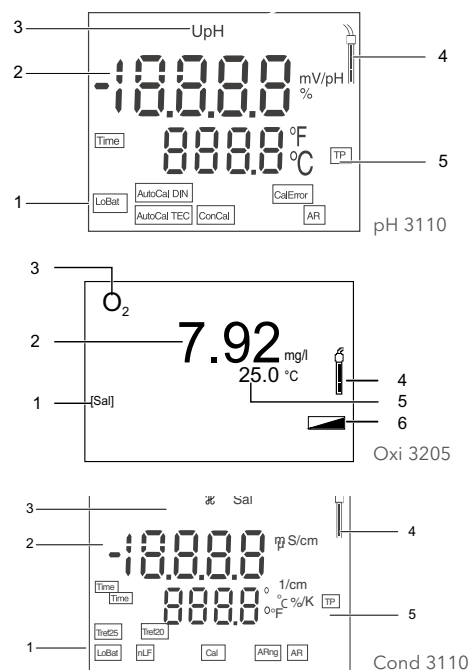

- 1 Status information
- 2 Measurement value (with unit)
- 3 Measured parameter
- 4 Sensor symbol (calibration evaluation)
- 5 Temperature measurement value (with unit)
- 6 Battery display

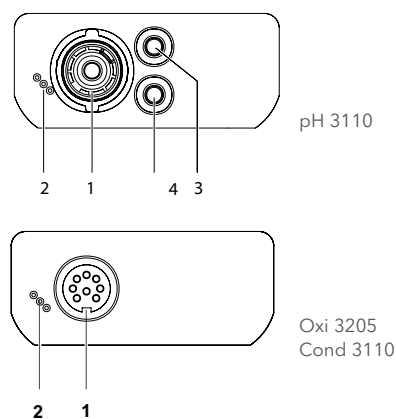

- 1 Connection for pH electrode or conductivity or dissolved oxygen sensor
- 2 Reference electrode (with pH measurement)
- 3 Temperature probe (with pH measurement)
- 4 Service interface

Order information see page
62 (pH) 90 (Oxi) 104 (Cond)